

65X57-K-2.0

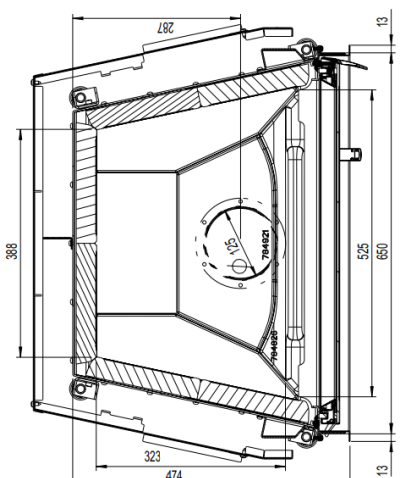

AUSTROFLAMM

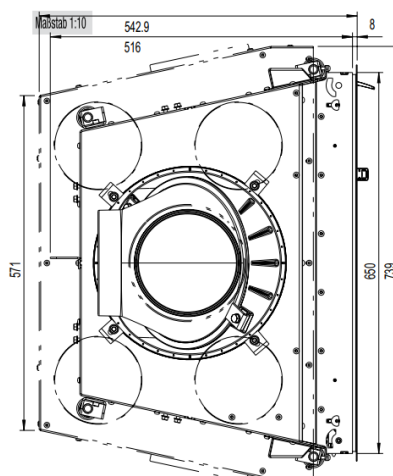
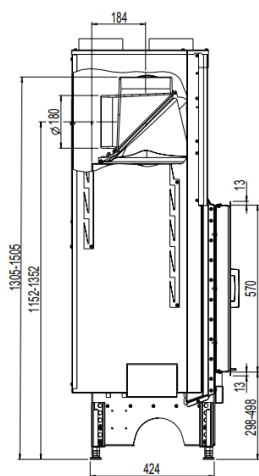
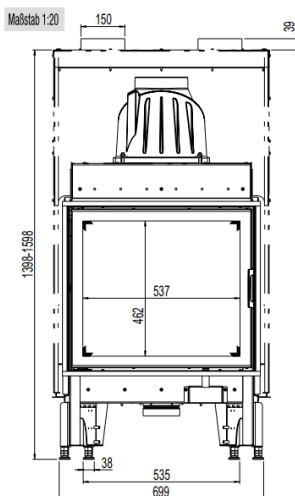

Dimensions and weight	
Height from [mm]	1301
Height to [mm]	1501
Width (body installation dimension) [mm]	656
Depth [mm]	477
Door frame height [mm]	570
Door frame width [mm]	656
Weight, basic appliance [kg]	127
Weight, HMS [kg]	61
Combustion chamber height [mm]	512
Combustion chamber width [mm]	388/536
Combustion chamber depth [mm]	323
Flue pipe outlet, diameter [mm]	180
dR Distance rear [mm]	0
dS1 Distance left [mm]	0
dS2 Distance right [mm]	0
dP Radiation front [mm]	1500
dF Radiation to the floor [mm]	-
dB Distance bottom [mm]	-
dL 1 Radiation left [mm]	-
dL 2 Radiation right [mm]	-
dC Distance above [mm]	750
Safety distance to insulation, rear [mm]	60
Safety distance to insulation, right [mm]	60
Safety distance to insulation, floor [mm]	0
Insulation material thickness to installation base [mm]	0
Insulation material thickness to ceiling [mm]	-
Minimum distance from non-flammable materials [mm]	50
Insulation material, left [mm]	100
Insulation material thickness, right [mm]	100
Insulation material, rear [mm]	100
Cross-section, convection outlet [cm ²]	700
Cross-section, convection inlet [cm ²]	700
Max. amount of firewood fuel to be deposited [kg]	2.1
Output	
Nominal heat efficiency [kW]	9.0
Minimum heat output [kW]	-
Maximum heat output [kW]	9.0
Energy efficiency class	A
Circulating air cross-section with metal heat recovery surface [cm ²]	1200
Circulating air cross-section without metal heat recovery surface [cm ²]	700
Combustion air requirement [m ³ /h]	34.56
Minimum fuel throughput [kg/h]	-
Maximum fuel throughput [kg/h]	2.7
Outside air connection diameter [Ø mm]	125
Data for the chimney sweep	
Exhaust gas mass flow [g/s]	10.5
Flue gas temperature [°C]	314
Minimum delivery pressure at nominal heat output [Pa]	11

- not available

Equipment	
Hinged door	Yes
Sliding door	No
Double pane	No
Pane curvature	Flat
Opening mechanism	Folding
Balanced flue - DiBt (German Institute for Structural Engineering)	-
Heat Memory System	Accessories
Hypocaust in compliance with technical regulations	Yes