

Montageanleitung / Assembly instructions  
Instructions de montage  
Istruzioni di montaggio

## Designrahmen montieren

Mounting the design frame  
Installer le cadre design  
Montaggio del telaio di design



**AUSTROFLAMM**

[www.austroflamm.com](http://www.austroflamm.com)

Originalbetriebsanleitung  
25/02/2025

Version: 1.0

#### IMPRESSUM

Eigentümer und Herausgeber

AUSTROFLAMM GMBH  
Austroflamm-Platz 1  
A- 4631 Krenglbach  
Tel: +43 (0) 7249 / 46 443  
[www.austroflamm.com](http://www.austroflamm.com)  
[info@austroflamm.com](mailto:info@austroflamm.com)

Redaktion: Olivera Stojanovic

Abbildungen: Konstruktion

Text: Technische Abteilung (Austroflamm)

#### Copyright

Alle Rechte vorbehalten. Der Inhalt dieser Anleitung darf nur mit Genehmigung des Herausgebers vervielfältigt oder verbreitet werden! Druck-, Rechtschreib- und Satzfehler vorbehalten.

Die Informationen in diesem Dokument können ohne vorherige Ankündigung geändert werden und stellen keine Verpflichtung seitens der Austroflamm GmbH dar. Für eventuelle Fehler in diesem Dokument übernimmt die Austroflamm GmbH keine Haftung.

## Inhaltsverzeichnis

Deutsch.....	4
English .....	8
Français.....	12
Italiano .....	16

## Inhaltsverzeichnis

1	Allgemeines.....	5
2	Designrahmen montieren (65x51 K 2.0).....	6

# 1 Allgemeines

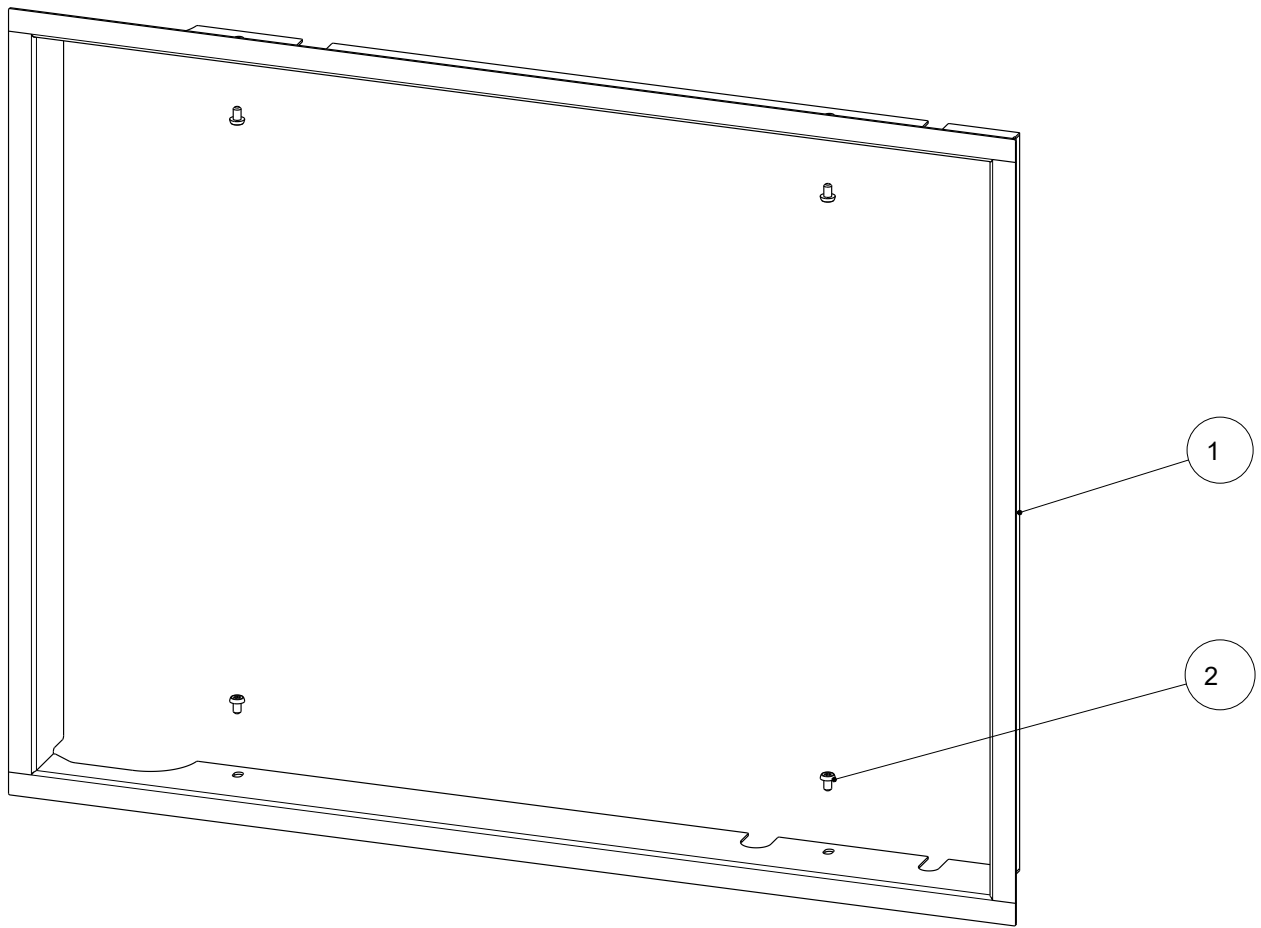

Pos. Nr.	Anzahl	Artikel	Artikel-Nr.
1	1	Designrahmen geschweißt	776734-29
2	4	Linsenschrauben mit ISK M5x8	718561-92

## 2 Designrahmen montieren (65x51 K 2.0)

### HINWEIS

Designrahmen dürfen weder angeputzt, noch verputzt, noch eingemauert werden.

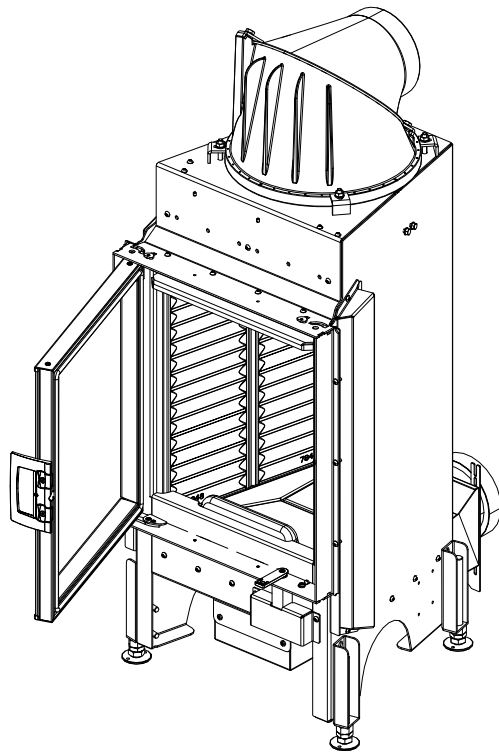
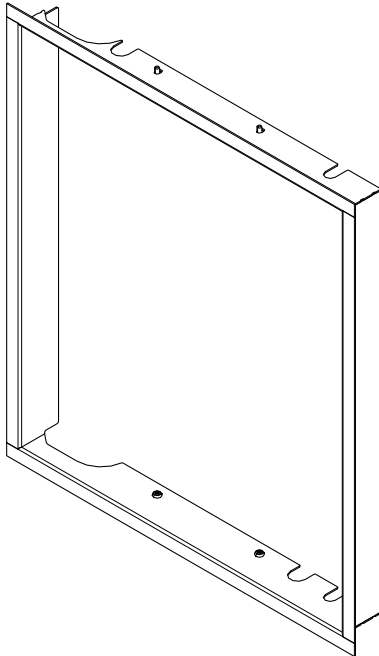

1) Tür öffnen.

Abb. 1: Tür öffnen



Abb. 2: Bolzen oben rausdrehen



Abb. 3: Bolzen unten rausdrehen

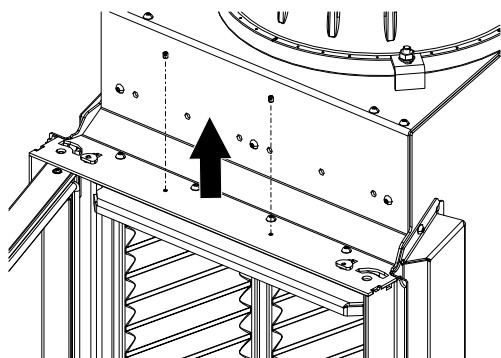

Abb. 4: Designrahmen anbringen

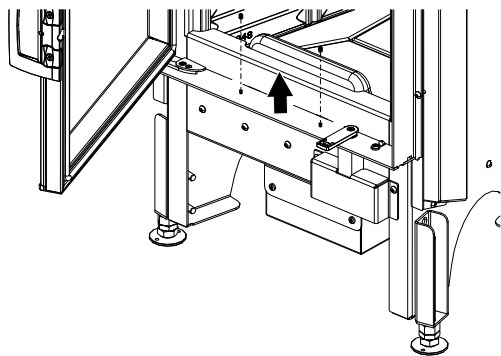

Abb. 5: Designrahmen befestigen

2) Die vier Bolzen (oben und unten) rausdrehen.

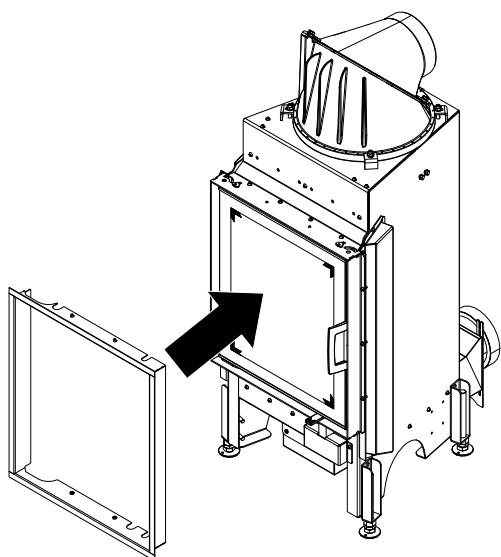
3) Tür schließen.

4) Designrahmen anbringen.

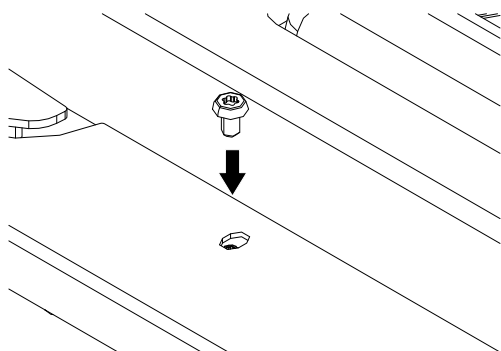
5) Tür öffnen.

6) Die Schrauben von Innen (oben und unten) montieren und Designrahmen befestigen.

## Contents

1	General.....	9
2	Mounting the design frame (65x51 K 2.0).....	10



# 1 General

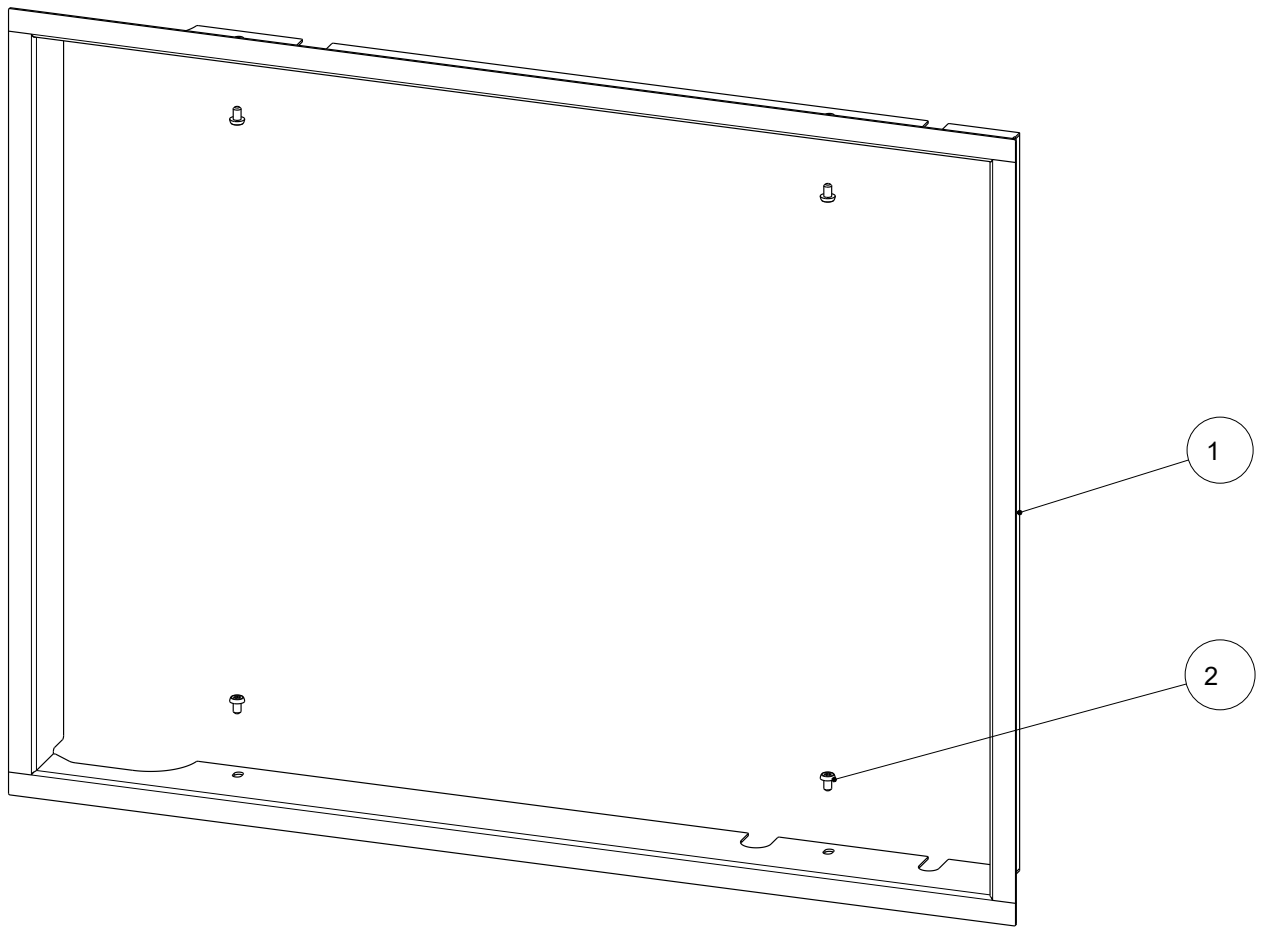

Item no.	Quantity	Article	Article no.
1	1	Design frame, welded	776734-29
2	4	Fillister-head screws with hex M5x8	718561-92

## 2 Mounting the design frame (65x51 K 2.0)

### NOTICE

Design frames must not be plastered over nor walled in.

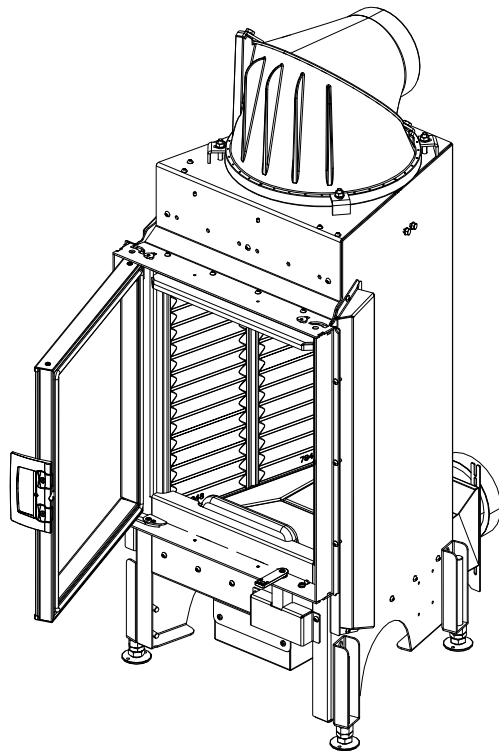
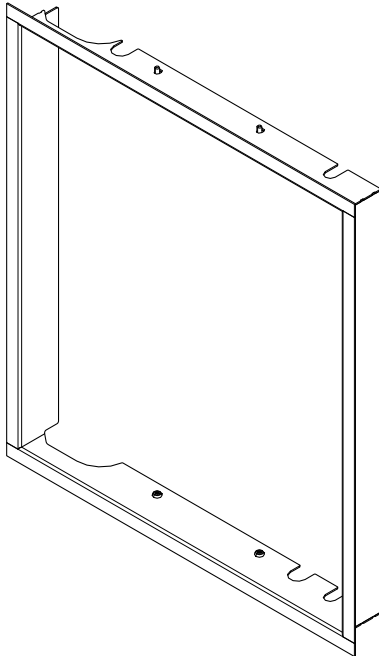

1) Open door.

Fig. 1: Opening the door

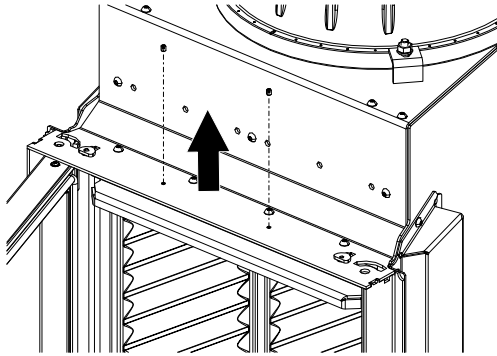

Fig. 2: Screwing out the bolts at the top

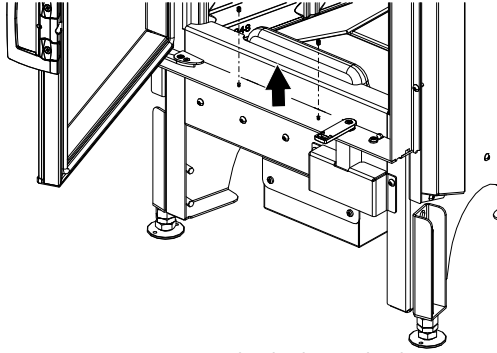

Fig. 3: Screwing out the bolts at the bottom

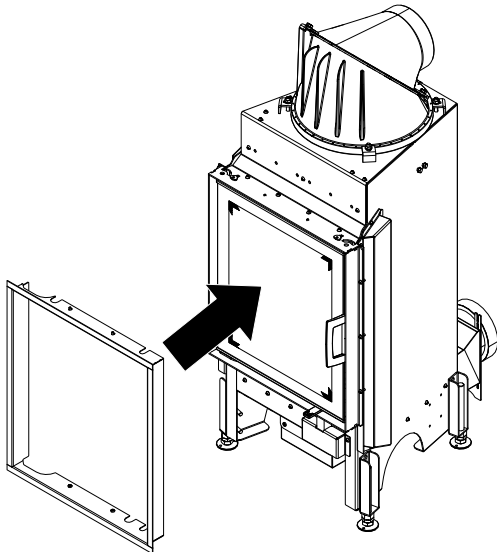

Fig. 4: Attaching the design frame

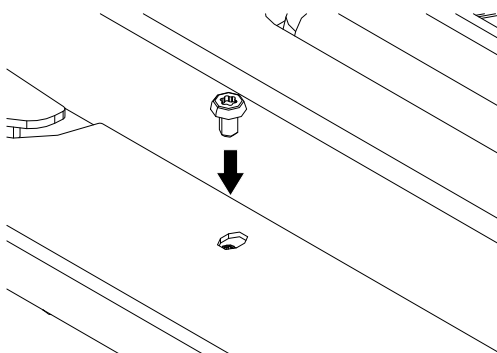

Fig. 5: Fastening the design frame

2) Screw out the four bolts (top and bottom).

- 3) Close door.
- 4) Attach design frame.

- 5) Open door.
- 6) Mount the screws from inside (top and bottom) and fasten design frame.

## Sommaire

<b>1</b>	<b>Généralités .....</b>	<b>13</b>
<b>2</b>	<b>Installer le cadre design (65x51 K 2.0) .....</b>	<b>14</b>

## 1 Généralités

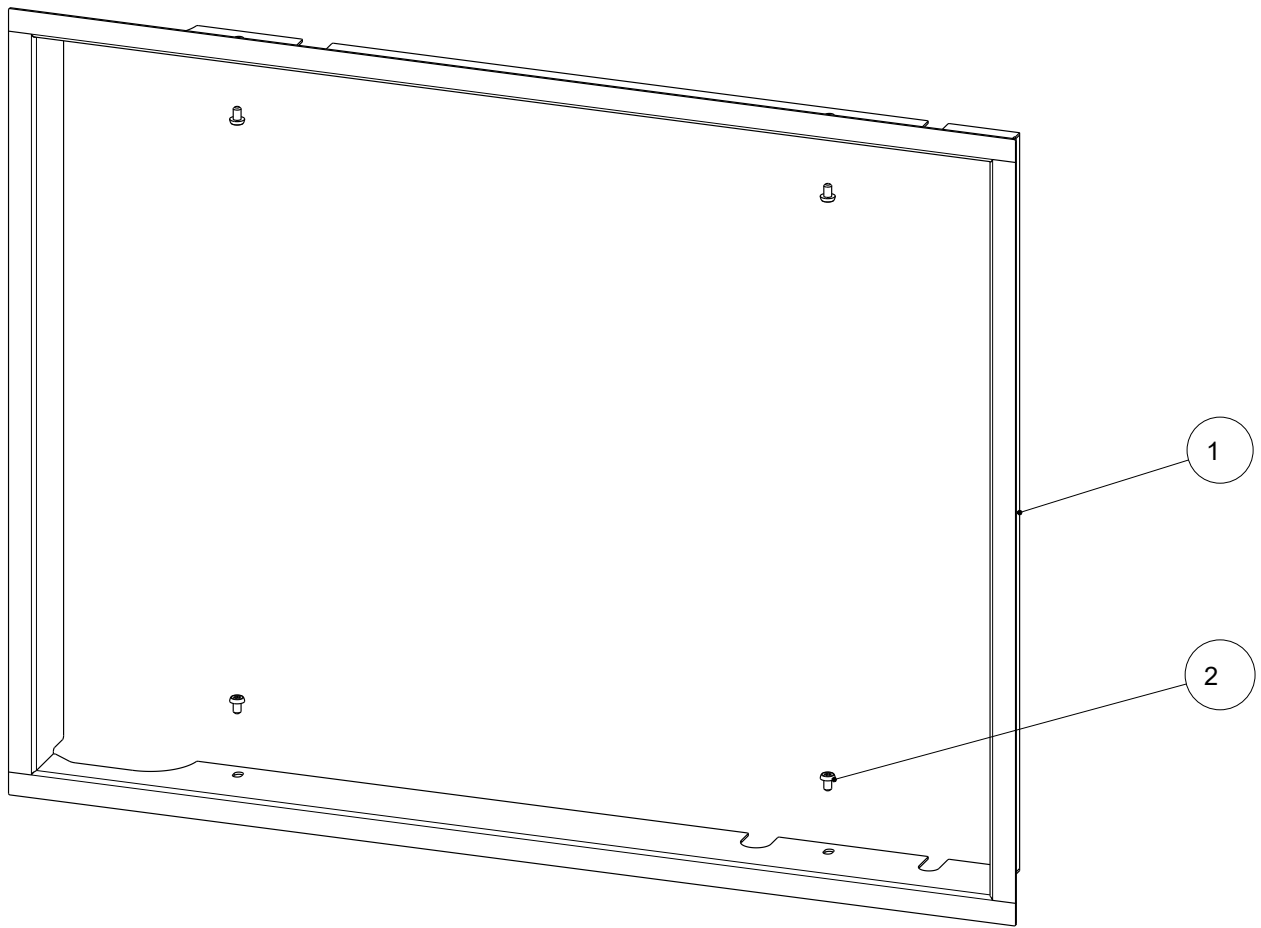

Pos. n°.	Quantité	Article	Article n°
1	1	Cadre design soudé	776734-29
2	4	Vis à tête bombée 6 pans creux M5x8	718561-92

## 2 Installer le cadre design (65x51 K 2.0)

### INDICATION

Les cadres design ne doivent être ni raccordés par de l'enduit, ni enduits, ni scellés dans un mur.

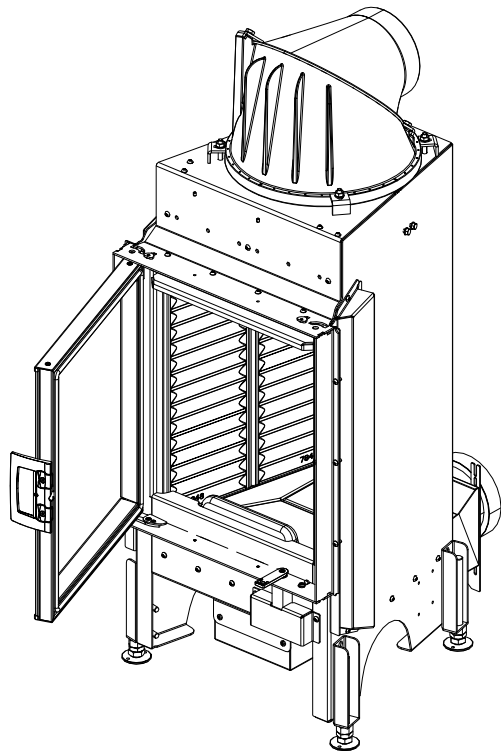
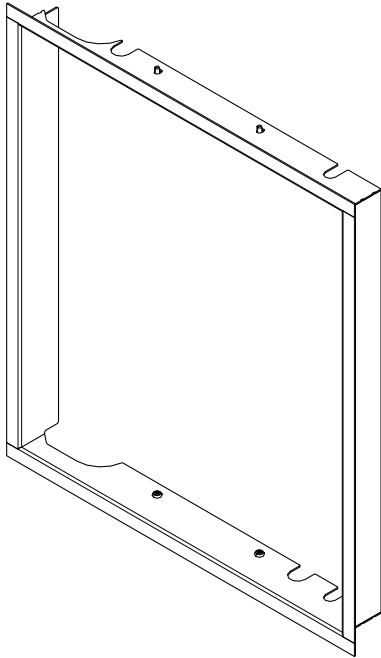

1) Ouvrir la porte.

Fig. 1: Ouvrir la porte

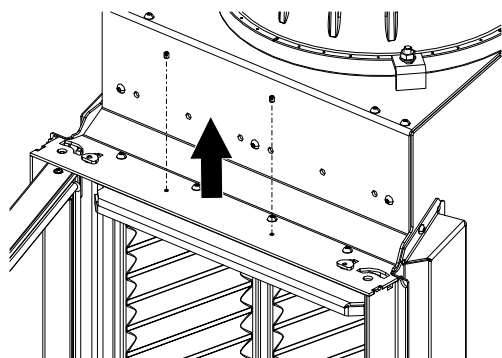

Fig. 2: Dévisser les boulons du haut

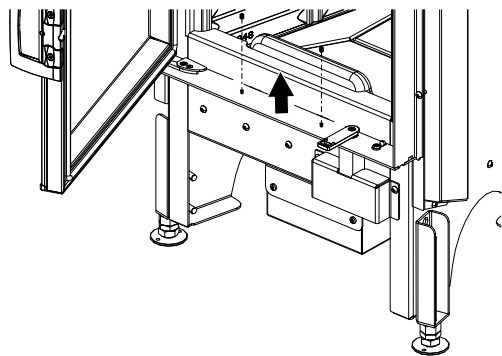

Fig. 3: Dévisser les boulons du bas

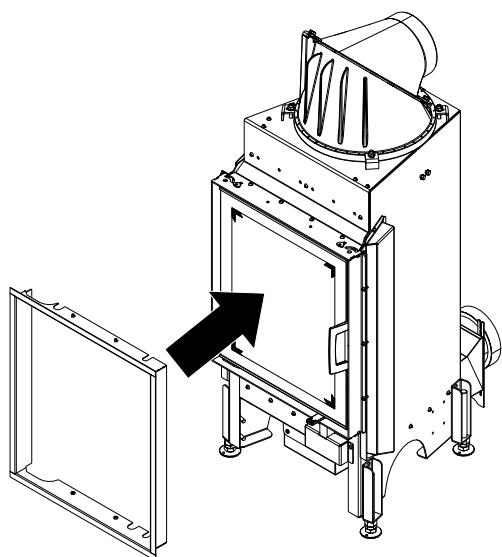

Fig. 4: Poser le cadre design

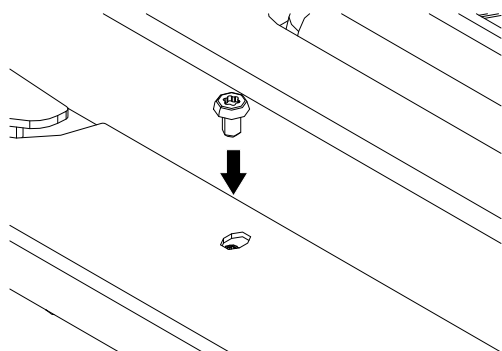

Fig. 5: Fixer le cadre design

2) Dévisser les quatre boulons (en haut et en bas).

3) Fermer la porte.

4) Poser le cadre design.

5) Ouvrir la porte.

6) Poser les vis de l'intérieur (en haut et en bas) et fixer le cadre design.

## Indice

1	Generalità .....	17
2	Montaggio della cornice di design (65x51 K 2.0).....	18



# 1 Generalità

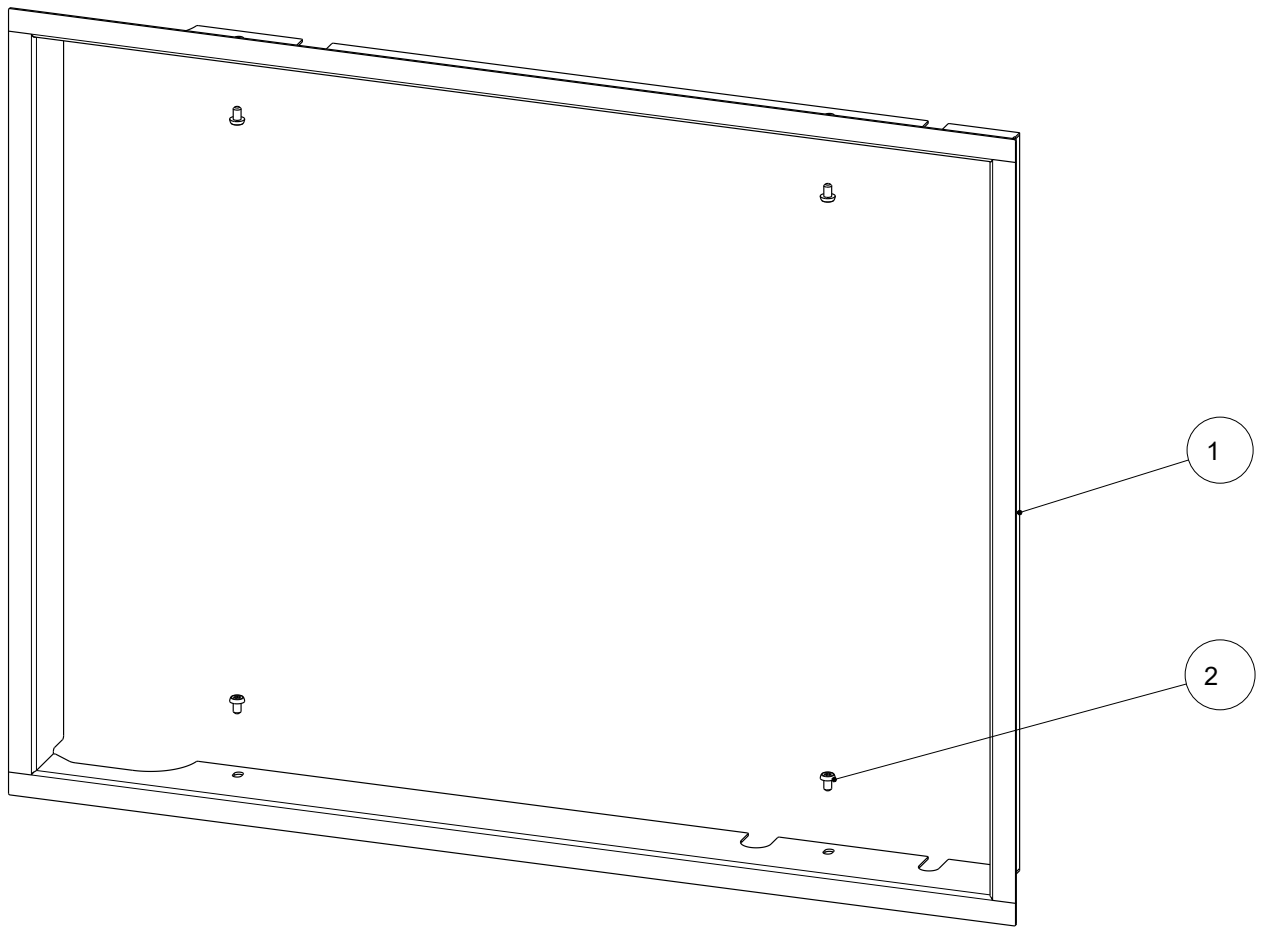

N. pos.	Q.tà	Articolo	N. art.
1	1	Telaio di design saldato	776734-29
2	4	Vite a testa bombata a testa bassa ISK M5x8	718561-92

## 2 Montaggio della cornice di design (65x51 K 2.0)

### AVVERTENZA

Le cornici di design non devono essere agghindate, stuccate o murate.

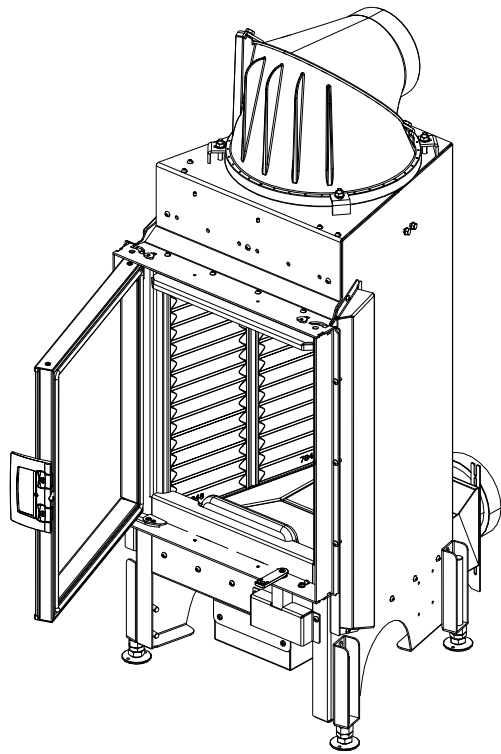
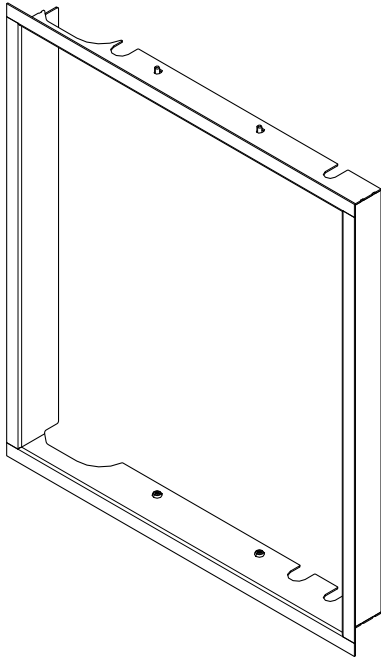

1) Aprire lo sportello.

Fig. 1: Apertura dello sportello

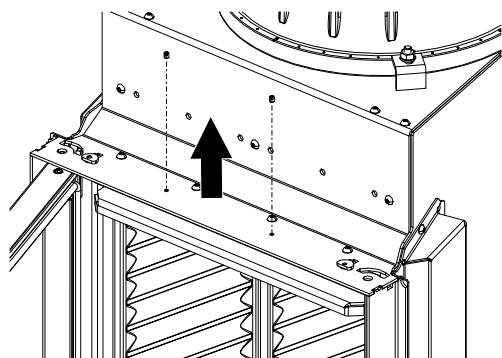

Fig. 2: Svitamento bulloni superiori

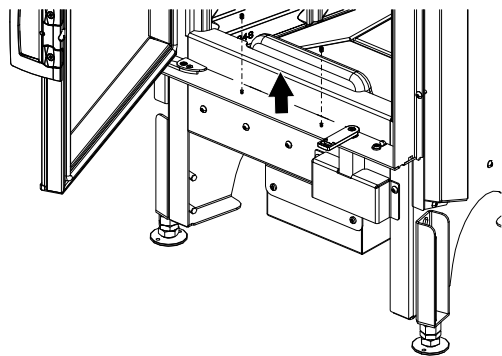

Fig. 3: Svitamento bulloni inferiori

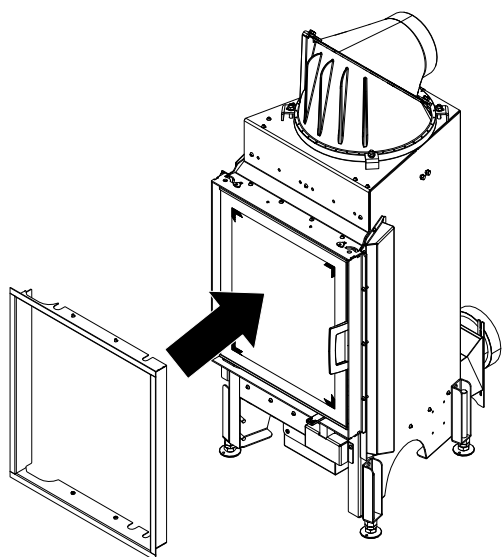

Fig. 4: Posizionamento della struttura di design

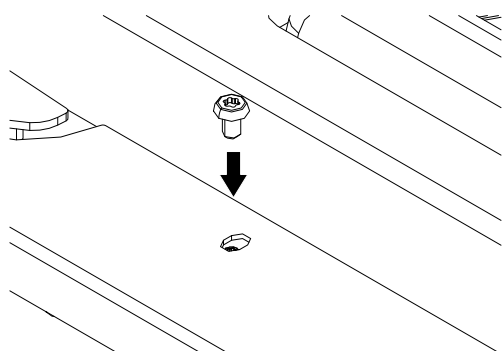

Fig. 5: Fissaggio della struttura di design

2) Svitare i quattro bulloni (in alto e in basso).

3) Chiudere lo sportello.

4) Posizionare la struttura di design.

5) Aprire lo sportello.

6) Montare dall'interno le viti (superiori e inferiori) e fissare la struttura.

AUSTROFLAMM GMBH  
Austroflamm-Platz 1  
A- 4631 Krenglbach

Tel: +43 (0) 7249 / 46 443  
[www.austroflamm.com](http://www.austroflamm.com)  
[info@austroflamm.com](mailto:info@austroflamm.com)

361314-945221

